



Shunt Switches Protected terminals

DER

DIN standard shunt
for direct current instruments



C48

ammetric and voltmetric switches
panel front frame 48x48 mm



CD3

ammetric and voltmetric switches
3 module



AV

protected terminals for KWh-meters



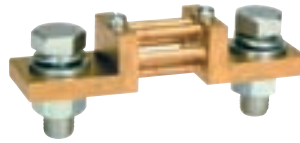

Model	DER								
	60mV			100mV			150mV		
Voltage drop	Ordering code	Stock		Ordering code	Stock		Ordering code	Stock	
Range	Ordering code	Stock		Ordering code	Stock		Ordering code	Stock	
1A	DER060A100	•		DER100A100			DER150A100		
1,5A	DER060A150	•		DER100A150			DER150A150		
2A	DER060A200	•		DER100A200			DER150A200		
2,5A	DER060A250	•		DER100A250			DER150A250		
3A	DER060A300	•		DER100A300			DER150A300		
4A	DER060A400	•		DER100A400			DER150A400		
5A	DER060A500	•		DER100A500			DER150A500		
6A	DER060A600	•		DER100A600			DER150A600		
8A	DER060A800	•		DER100A800			DER150A800		
10A	DER060B100	•		DER100B100			DER150B100	•	
15A	DER060B150	•		DER100B150			DER150B150	•	
20A	DER060B200	•		DER100B200			DER150B200		
25A	DER060B250	•		DER100B250			DER150B250	•	
30A	DER060B300	•		DER100B300			DER150B300		
40A	DER060B400	•		DER100B400			DER150B400	•	
50A	DER060B500	•		DER100B500			DER150B500		
60A	DER060B600	•		DER100B600			DER150B600	•	
80A	DER060B800	•		DER100B800			DER150B800		
100A	DER060C100	•		DER100C100			DER150C100	•	
120A	DER060C120	•		DER100C120			DER150C120		
150A	DER060C150	•		DER100C150			DER150C150	•	
200A	DER060C200	•		DER100C200			DER150C200		
250A	DER060C250	•		DER100C250			DER150C250	•	
300A	DER060C300	•		DER100C300			DER150C300		
400A	DER060C400	•		DER100C400			DER150C400	•	
500A	DER060C500	•		DER100C500			DER150C500		
600A	DER060C600	•		DER100C600			DER150C600	•	
800A	DER060C800	•		DER100C800			DER150C800		
1000A	DER060D100	•		DER100D100			DER150D100		
1200A	DER060D120	•		DER100D120			DER150D120		
1500A	DER060D150	•		DER100D150			DER150D150		
2000A	DER060D200	•		DER100D200			DER150D200		
2500A	DER060D250	•		DER100D250			DER150D250		
3000A	DER060D300			DER100D300			DER150D300		
4000A	DER060D400			DER100D400			DER150D400		
5000A	DER060D500			DER100D500			DER150D500		
6000A	DER060D600			DER100D600			DER150D600		



Voltmetric and ammetric switches



Model	C48								
Execution	switchboard, front frame 48x48 mm								
Description	Ordering code	Stock		Ordering code	Stock		Ordering code	Stock	
Single pole ammetric switch for 3 C.T. (12A-690V)	AV104	•							
3 interlinked voltages voltmetric switch (12A-690V)				AV105	•				
3 interlinked voltages and 3-phase neutral voltmetric (12A-690V)							AV106	•	



Model	CD3								
Execution	backboard, 3 module								
Description	Ordering code	Stock		Ordering code	Stock		Ordering code	Stock	
Single pole ammetric switch for 3 C.T. (12A-690V)	AV114	•							
3 interlinked voltages voltmetric switch (12A-690V)				AV115	•				
3 interlinked voltages and 3-phase neutral voltmetric (12A-690V)							AV116	•	

Protected terminals for KWh-meter

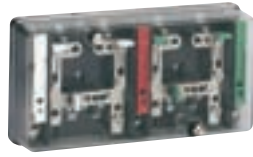

Description	Ordering code	Stock		Ordering code	Stock	
protected terminal for KWh-meter 3-phase 2 systems	AV201	•				
protected terminal for KWh-meter 3-phase 3 systems				AV202	•	

Switches

AV104 / AV114

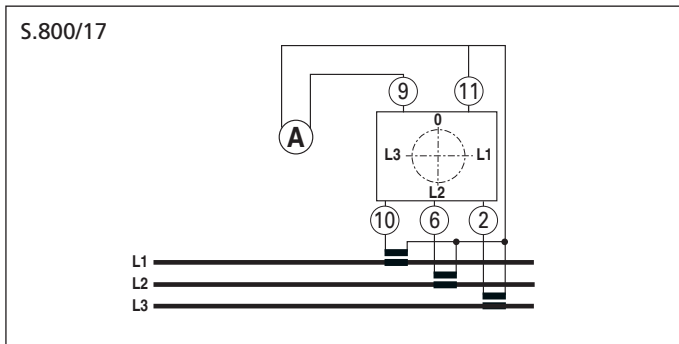

AV105 / AV115

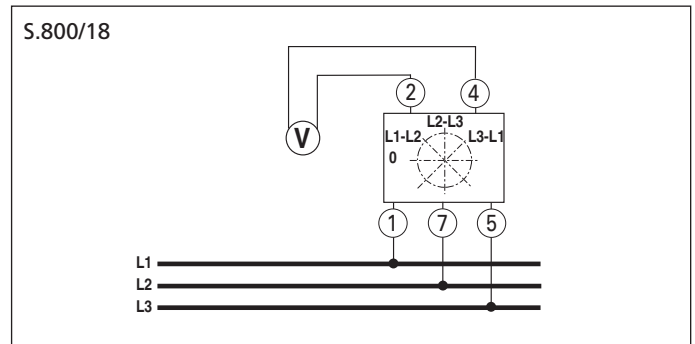

AV106 / AV116

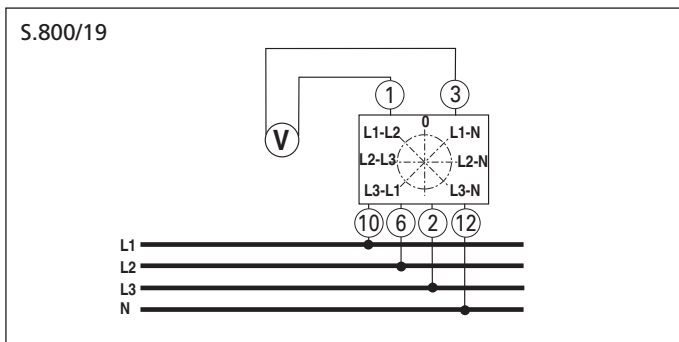

Protected terminals

AV201

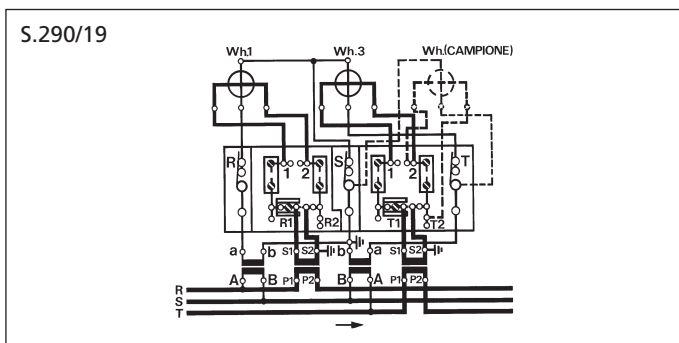

3-phase 2 systems KWh-meters

AV202

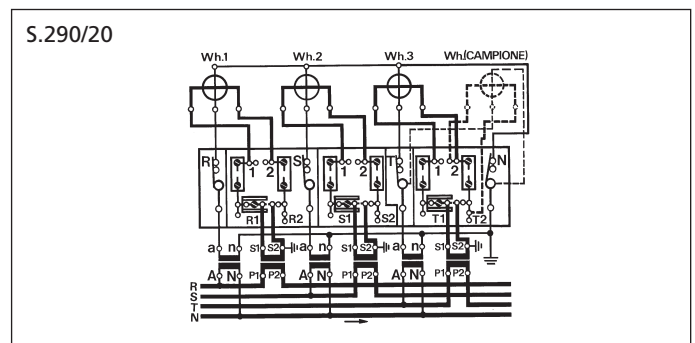

3-phase 3 systems KWh-meters

DER

DER series according to DIN standard (excluded 200A / 60mV / 150mV)

Range A	fig.	A	B	C	D	E	F	G	H	I
Voltage drop 60mV										
1-1,5-2-2,5-3-4-5	1	90	28	20	—	—	8	—	78	—
6-8-10-15-20-25	1	90	28	20	—	—	8	—	78	—
30-40-50-60-80-100-120-150-200	1	100	33	20	—	—	8	—	80	—
250-300	2	145	55	30	—	—	10	10	105	30
400-500-600	2	145	55	40	—	—	10	10	105	30
800-1000	2	165	65	60	—	—	10	10	115	30
1200-1500	3	165	65	90	21	48	10	10	115	30
2000-2500	3	165	65	120	30	60	10	10	115	30
3000-4000	4	165	65	120	30	60	15	10	115	60
5000-6000	5	175	70	154	25	52	25	15	125	130
Voltage drop 100mV										
1-1,5-2-2,5-3-4-5	1	90	28	20	—	—	8	—	78	—
6-8-10-15-20-25	1	90	28	20	—	—	8	—	78	—
30-40-50-60-80-100-120-150	1	123	33	20	—	—	8	—	103	—
200-250-300	2	168	55	30	—	—	10	10	128	30
400-500-600	2	168	55	40	—	—	10	10	128	30
800-1000	2	188	65	60	—	—	10	10	138	30
1200-1500	3	188	65	90	21	48	10	10	138	30
2000-2500	3	188	65	120	30	60	10	10	138	30
3000-4000	4	188	65	120	30	60	15	10	138	60
5000-6000	5	198	70	154	25	52	25	15	148	130
Voltage drop 150mV										
1-1,5-2-2,5-3-4-5	1	90	28	20	—	—	8	—	78	—
6-8-10-15-20-25	1	90	28	20	—	—	8	—	78	—
30-40-50-60-80-100-120-150-200	1	225	33	25	—	—	8	—	205	—
250-300	2	270	55	30	—	—	10	10	230	30
400-500-600	2	270	55	40	—	—	10	10	230	30
800-1000	2	290	65	60	—	—	10	10	240	30
1200-1500	3	290	65	90	21	48	15	10	240	60
2000-2500	3	290	65	120	30	60	15	10	240	60
3000-4000	4	300	70	120	30	60	25	15	250	130
5000-6000	5	300	70	154	25	52	25	15	250	130

Fig. 1

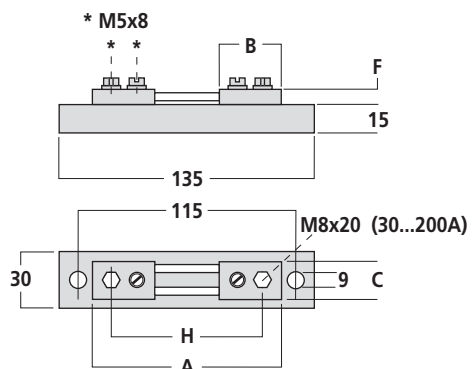

On base up to 25A

Fig. 2

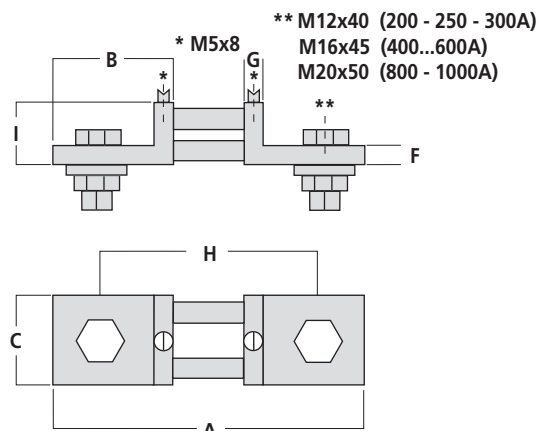

Fig. 3

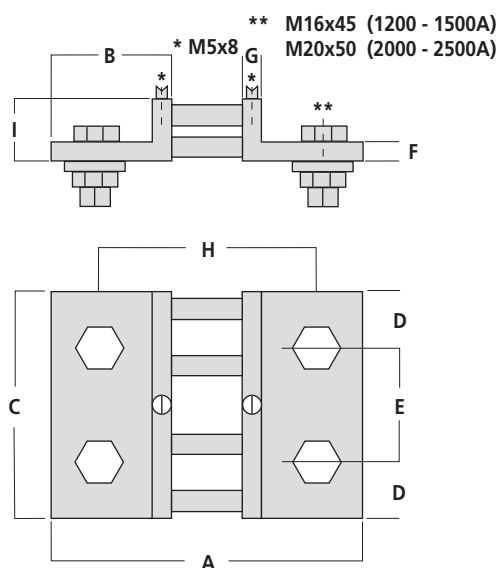

Fig. 4

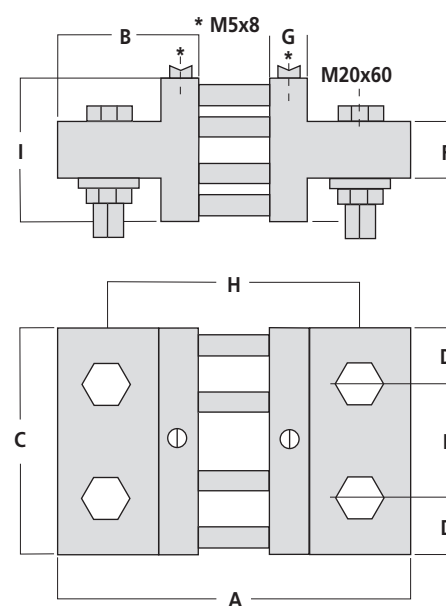
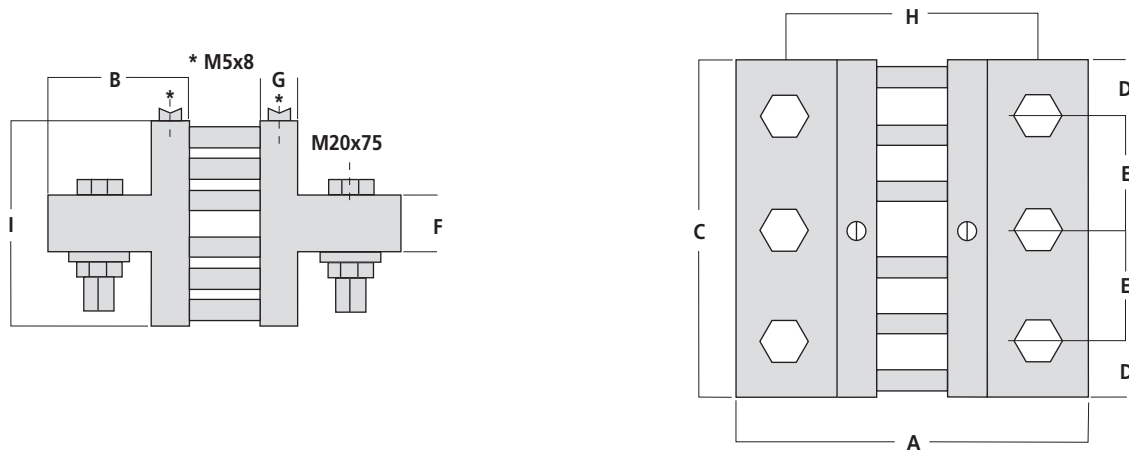
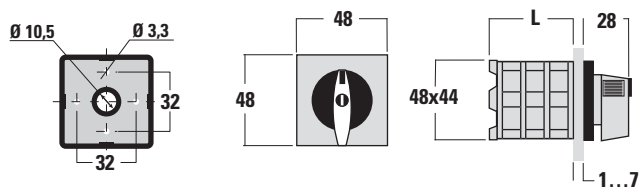

Fig. 5



AV104 / AV105 / AV106 - panel switch



AV105 (L = 53) / AV104 - 106 (L = 63)

AV114 / AV115 / AV116 - backboard switch

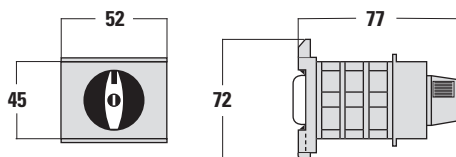

3 Module

AV201 - protected terminal

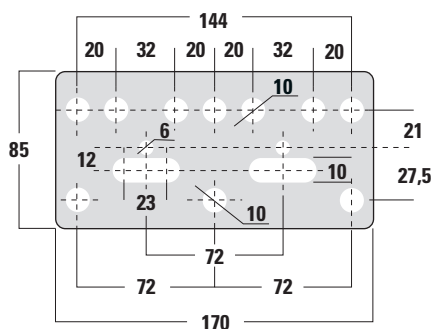

AV202 - protected terminal

